

WIN-WIN LIGHTING COMPANY LIMITED

11B, Huaxingge #128 Gangkou 1st Rd,
JiangMen, GuangDong, China 529000
Tel: +86 0750-3942600
Fax: +86 0750-3942602
www.win-winlighting.com
sales@win-winlighting.com
Skype: winwinlighting

Factory:
Block 10th, NanHua East Rd, HeTang Town,
PengJiang, Jiangmen City, GuangDong, China



PRODUCT CATALOG

LED LIGHTING

Global Commercial Lighting & Private Custom Advocator
Star Hotel, Commercial Chain, Villa Lighting



◉ HOTEL · COMMERCIAL CHAIN · RESTAURANT · CLUB & VILLA ◉



Win-Win Lighting

Win-Win Lighting has been specialized in designing, manufacturing and exporting high-class LED lighting for many years. We mainly produce recessed COB down light, track lights, panel lights, ceiling lights, grille lights, corner lights, T5/T8 tubes etc.

During the past years, our products have been exported to regions over the world such as Europe, Australia, Southeast Asia, India, Brazil and so on. has been recognized by domestic and overseas customers and praised by designers from optical field and lighting filed.

With the development of **Win-Win** brand, **Win-Win** people have established designing center, production center and sales center in China at the beginning of this century. The pursuit of **Win-Win** people is to create perfect light.

Our profession origins from ardent love...

www.win-winlighting.com

精準防眩 Precise Anti Glare

BOJO lamp's shielding angle reaches up to 45 degree,controlling glare at sight so as to make eyes feels comfortable and create pure light.

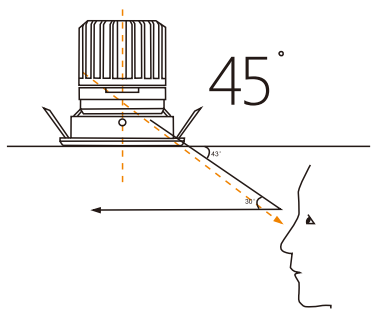

精確的光分佈和控制 Accurate Light Distribution And Control

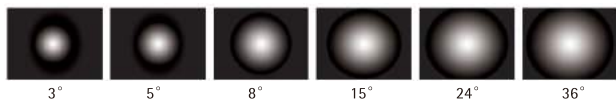

BOJO COB LED light have nine kinds of beam angle,3°/5°/8°/12°/15°/24°/36°/45°/60°
menting the diffent demands for lighting



TRIDONIC Driver

PHILIPS Driver

EAGLERISE Driver

BOJO Driver

Contents >>

005-065	Wall Wash Downlights
078-109	Grille Lamp
113-212	High Power Spotlights
215-292	Track Lights
293-301	Canister Light
305-316	Office Light
317-318	Smd Lamp
318-319	T5 Led Tube
321-326	Conner Lamp
327-328	Wall Light
329-332	Model Combination

WW-580A

WW-580E

WW-580D

WW-580F

WW-580RF

WW-580RA

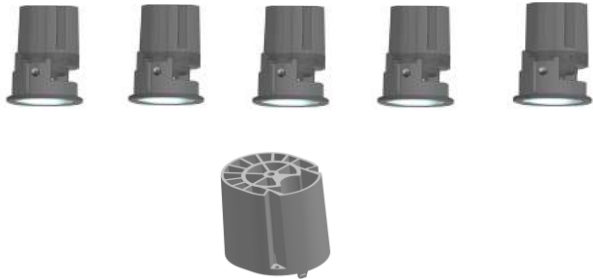

LED COB 15°

Power	10W	10W	10W
CCT	2700K	3000K	4000K
CRI	>80	>80	>80
Output v	32V DC	32V DC	32V DC
Output I	280mA	280mA	280mA
Efficacy	63lm/w	66lm/w	70lm/w

LED COB 24°

Power	10W	10W	10W
CCT	2700K	3000K	4000K
CRI	>80	>80	>80
Output v	32V DC	32V DC	32V DC
Output I	280mA	280mA	280mA
Efficacy	60lm/w	61lm/w	65lm/w

LED COB 35°

Power	10W	10W	10W
CCT	2700K	3000K	4000K
CRI	>80	>80	>80
Output v	32V DC	32V DC	32V DC
Output I	280mA	280mA	280mA
Efficacy	54lm/w	55lm/w	58lm/w

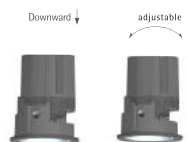

WW-115A WW-115E

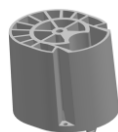
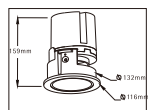

LED COB 15°

Power	27W	27W	27W
CCT	2700K	3000K	4000K
CRI	>80	>80	>80
Output v	35V DC	35V DC	35V DC
Output I	700mA	700mA	700mA
Efficacy	87lm/w	87lm/w	93lm/w

LED COB 28°

Power	27W	27W	27W
CCT	2700K	3000K	4000K
CRI	>80	>80	>80
Output v	35V DC	35V DC	35V DC
Output I	700mA	700mA	700mA
Efficacy	70lm/w	70lm/w	76lm/w

LED COB 37°

Power	27W	27W	27W
CCT	2700K	3000K	4000K
CRI	>80	>80	>80
Output v	35V DC	35V DC	35V DC
Output I	700mA	700mA	700mA
Efficacy	78lm/w	82lm/w	82lm/w



WW-120AE



WW-135A



WW-155A

LED COB 15°

Power	20W	20W	20W
CCT	2700K	3000K	4000K
CRI	>80	>80	>80
Output v	35V DC	35V DC	35V DC
Output I	500mA	500mA	500mA
Efficacy	85lm/w	91lm/w	93lm/w
Diameter:Φ135mm	H:160mm	cut size Φ120mm	
Diameter:Φ145mm	H:150mm	cut size Φ135mm	
Diameter:Φ168mm	H:165mm	cut size Φ155mm	

LED COB 30°

Power	20W	20W	20W
CCT	2700K	3000K	4000K
CRI	>80	>80	>80
Output v	35V DC	35V DC	35V DC
Output I	500mA	500mA	500mA
Efficacy	84lm/w	85lm/w	89lm/w
Diameter:Φ135mm	H:160mm	cut size Φ120mm	
Diameter:Φ145mm	H:150mm	cut size Φ135mm	
Diameter:Φ168mm	H:165mm	cut size Φ155mm	

LED COB 38°

Power	20W	20W	20W
CCT	2700K	3000K	4000K
CRI	>80	>80	>80
Output v	35V DC	35V DC	35V DC
Output I	500mA	500mA	500mA
Efficacy	84lm/w	86lm/w	88lm/w
Diameter:Φ135mm	H:160mm	cut size Φ120mm	
Diameter:Φ145mm	H:150mm	cut size Φ135mm	
Diameter:Φ168mm	H:165mm	cut size Φ155mm	

LED COB 56°

Power	20W	20W	20W
CCT	2700K	3000K	4000K
CRI	>80	>80	>80
Output v	35V DC	35V DC	35V DC
Output I	500mA	500mA	500mA
Efficacy	74lm/w	84lm/w	79lm/w
Diameter:Φ135mm	H:160mm	cut size Φ120mm	
Diameter:Φ145mm	H:150mm	cut size Φ135mm	
Diameter:Φ168mm	H:165mm	cut size Φ155mm	

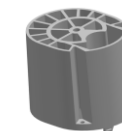



WW-73D WW-73E WW-73A WW-73A



LED COB

Power	7W
CCT	2700K 3000K 4000K 5000K
CRI	>90
Input voltage	110-240VAC
Beam Angel	15°/24°/45°
Color	Black/White
Ceiling Thickness	3-20mm
Size	Diameter:Φ90mm H:78mm
Cut out	Φ 73mm

LED COB



WW-73A

Power	10W
CCT	2700K 3000K 4000K 5000K
CRI	>90
Input voltage	110-240VAC
Beam Angel	15°/24°/45°
Color	Black/White
Ceiling Thickness	3-20mm
Size	Diameter:Φ 100mm H:92mm
Cut out	Φ 80mm

LED COB

Power	20W
CCT	2700K 3000K 4000K 5000K
CRI	>90
Input voltage	110-240VAC
Beam Angel	15°/24°/45°
Color	Black/White
Ceiling Thickness	3-20mm
Size	Diameter:Φ 100mm H:92mm
Cut out	Φ 80mm



WW-A6.5 WW-A12 WW-A20

LED COB

Power	6.5W/12W/20W
CCT	2700K 3000K 4000K 5000K
CRI	>90
Input voltage	110-240VAC
Beam Angel	15°/24°/38°
Color	Black/White
Ceiling Thickness	3-20mm
Size	Diameter:Φ185mm/210mm/210mm H:138mm/160mm/188mm
Cut out	Φ110*110mm/135*135mm/135*135mm

LED COB

Power	6.5W
CCT	2700K 3000K 4000K 5000K
CRI	>90
Input voltage	110-240VAC
Beam Angel	15°
Color	Black/White
Ceiling Thickness	3-20mm
Size	Diameter:Φ 88mm H:65mm
Cut out	Φ 60mm



WW-A6.5 WW-A12 WW-A20

LED COB

Power	12W
CCT	2700K 3000K 4000K 5000K
CRI	>90
Input voltage	110-240VAC
Beam Angel	18°
Color	Black/White
Ceiling Thickness	3-20mm
Size	Diameter:Φ 63mm H:100mm
Cut out	Φ 75mm



WW-A6.5 WW-A12 WW-A20



WW-675A

WW-675D

WW-675E

WW-675F

LED COB

Power	10W
CCT	2700K 3000K 4000K 5000K
CRI	>90
Input voltage	110-240VAC
Beam Angel	15°/24°/45°
Color	Black/White
Ceiling Thickness	3-20mm
Size	Diameter:Φ 110mm H:100mm
Cut out	Φ 85mm



WW-45A6.5

WW-45C6.5

LED COB

Power	6.5W
CCT	2700K 3000K 4000K 5000K
CRI	>90
Input voltage	110-240VAC
Beam Angel	15°/24°/38°
Color	Black/White
Ceiling Thickness	3-20mm
Size	Diameter:Φ 60mm H:65mm
Cut out	Φ 45mm



WW-60C6.5

WW-60D6.5

WW-60F6.5

LED COB

Power	6.5W
CCT	2700K 3000K 4000K 5000K
CRI	>90
Input voltage	110-240VAC
Beam Angel	15°
Color	Black/White
Ceiling Thickness	3-20mm
Size	Diameter:Φ 67mm H:65mm
Cut out	Φ 60mm



WW-565A-12W

WW-565C-12W



WW-775C-12W

WW-775D-12W

WW-775F-12W

LED COB

Power	12W
CCT	2700K 3000K 4000K 5000K
CRI	>90
Input voltage	110-240VAC
Beam Angel	18°/24°/38°
Color	Black/White
Ceiling Thickness	3-20mm
Size	Diameter:Φ 72mm H:55mm
Cut out	Φ 75mm

LED COB

Power	12W
CCT	2700K 3000K 4000K 5000K
CRI	>90
Input voltage	110-240VAC
Beam Angel	18°
Color	Black/White
Ceiling Thickness	3-20mm
Size	Diameter:Φ 87mm H:63mm
Cut out	Φ 75mm



WW-080-10W

LED COB

Power	10W
CCT	2700K 3000K 4000K 5000K
CRI	≥90
Input voltage	110-240VAC
Beam Angel	15°, 24°, 40° Lens: 12° 24°
Color	Black/White
Ceiling Thickness	3-20mm
Size	Diameter:Φ 100mm H:110mm
Cut out	Φ 85mm



WW-65F 10/9W WW-65HL 10/9W WW-65E 10/9W WW-65A 10/9W



WW-65DL 10/9W WW-65DS 10/9W WW-65CFX 10/9W WW-65FX 10/9W

LED COB

Power	10W/9W
CCT	2700K 3000K 4000K 5000K
CRI	>90
Input voltage	110-240VAC
Beam Angel	15°,24°,40° Lens:12°24°
Color	Black/White
Ceiling Thickness	3-20mm
Size	Diameter:Φ 108mm H:108mm
Cut out	Φ 95mm



WW-75A 10/9W WW-75E 10/9W WW-75HL 10/9W



WW-75DS 10/9W WW-75DL 10/9W WW-75F 10/9W

LED COB

Power	10W/9W
CCT	2700K 3000K 4000K 5000K
CRI	>90
Input voltage	110-240VAC
Beam Angel	15°,24°,40° Lens:12°24°
Color	Black/White
Ceiling Thickness	3-20mm
Size	Diameter:Φ 86mm H:104mm
Cut out	Φ 75mm



WW-682F 10/9W WW-682HL 10/9W WW-682E 10/9W WW-682A 10/9W



WW-682DL 10/9W WW-682DS 10/9W WW-682CFX 10/9W WW-682FX 10/9W

LED COB

Power	10W/9W
CCT	2700K 3000K 4000K 5000K
CRI	>90
Input voltage	110-240VAC
Beam Angel	15°,24°,40° Lens:12°24°
Color	Black/White
Ceiling Thickness	3-20mm
Size	Diameter:Φ 96mm H:104mm
Cut out	Φ 85mm



WW-YZA-45W

WW-YZA-30W

WW-YZE-45W

WW-YZE-30W

LED COB

Power	30W/45W
CCT	2700K 3000K 4000K 5000K
CRI	>90
Input voltage	110-240VAC
Beam Angel	15°,24° Lens:12° 24°
Color	Black/White
Ceiling Thickness	3-20mm
Size	Diameter:Φ168mm H:170mm
Cut out	Φ161mm



WW-130A-20W

WW-130E-20W

WW-110A-20W

WW-110E-20W

WW-5YA-20W

WW-5YE-20W

LED COB

Power	20W
CCT	2700K 3000K 4000K 5000K
CRI	>90
Input voltage	110-240VAC
Beam Angel	15°,24°,38°,60° Lens:12° 24°
Color	Black/White
Ceiling Thickness	3-20mm
Size	Diameter:Φ 145mm AH:138mm
Cut out	Φ 130mm EH:142mm

LED COB

Power	20W
CCT	2700K 3000K 4000K 5000K
CRI	>90
Input voltage	110-240VAC
Beam Angel	15°,24°,38°,60° Lens:12° 24°
Color	Black/White
Ceiling Thickness	3-20mm
Size	Diameter:Φ 128mm AH:127mm
Cut out	Φ 110mm EH:135mm

LED COB

Power	20W
CCT	2700K 3000K 4000K 5000K
CRI	>90
Input voltage	110-240VAC
Beam Angel	15°,24°,38°,60° Lens:12° 24°
Color	Black/White
Ceiling Thickness	3-20mm
Size	Diameter:Φ 108mm AH:128mm
Cut out	Φ100mm EH:100mm



WW-205-T/20W

LED COB

Power	20W
CCT	2700K 3000K 4000K 5000K
CRI	≥90
Input voltage	110-240VAC
Beam Angel	10°,24° Lens:12° 24°
Color	Black/White
Ceiling Thickness	3-20mm
Size	Diameter:Φ 170mm H:80mm
Cut out	Φ 155mm

WW-306-S/30W

LED COB

Power	30W
CCT	2700K 3000K 4000K 5000K
CRI	≥90
Input voltage	110-240VAC
Beam Angel	110°
Color	Black/White
Ceiling Thickness	3-20mm
Size	Diameter:Φ 190mm H:80mm
Cut out	Φ 175mm

WW-508-T/45W

LED COB

Power	45W
CCT	2700K 3000K 4000K 5000K
CRI	≥90
Input voltage	110-240VAC
Beam Angel	10°,60° Lens:12° 24°
Color	Black/White
Ceiling Thickness	3-20mm
Size	Diameter:Φ 230mm H:82mm
Cut out	Φ 210mm

WW-124-T/12W

LED COB

Power	12W
CCT	2700K 3000K 4000K 5000K
CRI	≥90
Input voltage	110-240VAC
Beam Angel	10°,24° Lens:12° 24°
Color	Black/White
Ceiling Thickness	3-20mm
Size	Diameter:Φ 135mm H:80mm
Cut out	Φ 120mm

WW-205-S/20W

LED COB

Power	20W
CCT	2700K 3000K 4000K 5000K
CRI	≥90
Input voltage	110-240VAC
Beam Angel	110°
Color	Black/White
Ceiling Thickness	3-20mm
Size	Diameter:Φ 170mm H:80mm
Cut out	Φ 155mm

WW-306-T/30W

LED COB

Power	30W
CCT	2700K 3000K 4000K 5000K
CRI	≥90
Input voltage	110-240VAC
Beam Angel	10°,24° Lens:12° 24°
Color	Black/White
Ceiling Thickness	3-20mm
Size	Diameter:Φ 190mm H:80mm
Cut out	Φ 175mm

WW-508-S/45W

LED COB

Power	45W
CCT	2700K 3000K 4000K 5000K
CRI	≥90
Input voltage	110-240VAC
Beam Angel	10°
Color	Black/White
Ceiling Thickness	3-20mm
Size	Diameter:Φ 230mm H:82mm
Cut out	Φ 210mm

WW-124-S/10W

LED COB

Power	10W
CCT	2700K 3000K 4000K 5000K
CRI	≥90
Input voltage	110-240VAC
Beam Angel	110°
Color	Black/White
Ceiling Thickness	3-20mm
Size	Diameter:Φ 135mm H:80mm
Cut out	Φ 120mm



WW-LED-COB-2W

Power	2W
CCT	2700K 3000K 4000K 5000K
CRI	>90
Input voltage	110-240VAC
Beam Angel	15°/30°/45°
Color	Black/White
Ceiling Thickness	3-20mm
Size	Diameter:Φ 45mm H:45mm
Cut out	Φ 37*37mm



WW-LED-COB-2*2W

Power	2*2W
CCT	2700K 3000K 4000K 5000K
CRI	>90
Input voltage	110-240VAC
Beam Angel	15°/30°/45°
Color	Black/White
Ceiling Thickness	3-20mm
Size	Diameter:Φ 75mm H:45mm
Cut out	Φ 68*37mm



WW-LED-COB-5*2W

Power	5*2W
CCT	2700K 3000K 4000K 5000K
CRI	>90
Input voltage	110-240VAC
Beam Angel	15°/30°/45°
Color	Black/White
Ceiling Thickness	3-20mm
Size	Diameter:Φ147mm H:45mm
Cut out	Φ 140*37mm



WW-LED-COB-10*2W

Power	10*2W
CCT	2700K 3000K 4000K 5000K
CRI	>90
Input voltage	110-240VAC
Beam Angel	15°/30°/45°
Color	Black/White
Ceiling Thickness	3-20mm
Size	Diameter:Φ280mm H:45mm
Cut out	Φ 273*37mm



WW-LED-COB-15*2W

Power	10*2W
CCT	2700K 3000K 4000K 5000K
CRI	>90
Input voltage	110-240VAC
Beam Angel	15°/30°/45°
Color	Black/White
Ceiling Thickness	3-20mm
Size	Diameter:Φ280mm H:45mm
Cut out	Φ 273*37mm



WW-65A-10W

LED COB

Power	10W
CCT	2700K 3000K 4000K 5000K
CRI	>90
Input voltage	110-240VAC
Beam Angel	15°,24°,40° Lens:12°24°
Color	Black/White
Ceiling Thickness	3-20mm
Size	120*120mm
Cut out	100*100mm

WW-85A-20W

LED COB

Power	20W
CCT	2700K 3000K 4000K 5000K
CRI	>90
Input voltage	110-240VAC
Beam Angel	15°,24°,38° Lens:12°24°
Color	Black/White
Ceiling Thickness	3-20mm
Size	160*160mm
Cut out	143*145mm

WW-104A-30W

LED COB

Power	30W
CCT	2700K 3000K 4000K 5000K
CRI	>90
Input voltage	110-240VAC
Beam Angel	15°,24° Lens:12°24°
Color	Black/White
Ceiling Thickness	3-20mm
Size	189*189mm
Cut out	173*173mm



WW-65A-2*10W

LED COB

Power	2*10W
CCT	2700K 3000K 4000K 5000K
CRI	>90
Input voltage	110-240VAC
Beam Angel	15°,24°,40° Lens:12°24°
Color	Black/White
Ceiling Thickness	3-20mm
Size	210*120mm
Cut out	190*107mm

WW-85A-2*20W

LED COB

Power	2*20W
CCT	2700K 3000K 4000K 5000K
CRI	>90
Input voltage	110-240VAC
Beam Angel	15°,24°,38° Lens:12°24°
Color	Black/White
Ceiling Thickness	3-20mm
Size	274*160mm
Cut out	245*145mm

WW-104A-2*30W

LED COB

Power	2*30W
CCT	2700K 3000K 4000K 5000K
CRI	>90
Input voltage	110-240VAC
Beam Angel	15°,24° Lens:12°24°
Color	Black/White
Ceiling Thickness	3-20mm
Size	350*190mm
Cut out	320*173mm



WW-65A 3*10W

LED COB

Power	3*10W
CCT	2700K 3000K 4000K 5000K
CRI	>90
Input voltage	110-240VAC
Beam Angel	15°,24°,40° Lens:12°24°
Color	Black/White
Ceiling Thickness	3-20mm
Size	312*130mm
Cut out	285*117mm

WW-85A 3*20W

LED COB

Power	3*20W
CCT	2700K 3000K 4000K 5000K
CRI	>90
Input voltage	110-240VAC
Beam Angel	15°,24°,38° Lens:12°24°
Color	Black/White
Ceiling Thickness	3-20mm
Size	395*160mm
Cut out	365*145mm

WW-104-3*30W

LED COB

Power	3*30W
CCT	2700K 3000K 4000K 5000K
CRI	>90
Input voltage	110-240VAC
Beam Angel	15°,24° Lens:12°24°
Color	Black/White
Ceiling Thickness	3-20mm
Size	513*190mm
Cut out	475*173mm



WW-104-5W

LED COB

Power	5W
CCT	2700K 3000K 4000K 5000K
CRI	>90
Input voltage	110-240VAC
Beam Angel	24°
Color	Black/White
Ceiling Thickness	3-20mm
Size	102*103mm
Cut out	85*85mm



WW-204A-2*5W

LED COB

Power	2*5W
CCT	2700K 3000K 4000K 5000K
CRI	>90
Input voltage	110-240VAC
Beam Angel	24°
Color	Black/White
Ceiling Thickness	3-20mm
Size	181*102mm
Cut out	160*85mm



WW-304-3*5W

LED COB

Power	3*5W
CCT	2700K 3000K 4000K 5000K
CRI	>90
Input voltage	110-240VAC
Beam Angel	24°
Color	Black/White
Ceiling Thickness	3-20mm
Size	255*102mm
Cut out	240*85mm



WW-105A-45W

LED COB

Power	45W
CCT	2700K 3000K 4000K 5000K
CRI	>90
Input voltage	110-240VAC
Beam Angel	15°,24° Lens:12°24°
Color	Black/White
Ceiling Thickness	3-20mm
Size	189*189mm
Cut out	173*173mm



WW-105A-2*45W

LED COB

Power	2*45W
CCT	2700K 3000K 4000K 5000K
CRI	>90
Input voltage	110-240VAC
Beam Angel	15°,24° Lens:12°24°
Color	Black/White
Ceiling Thickness	3-20mm
Size	352*188mm
Cut out	320*173mm



WW-105A-3*45W

LED COB

Power	2*45W
CCT	2700K 3000K 4000K 5000K
CRI	>90
Input voltage	110-240VAC
Beam Angel	15°,24° Lens:12°24°
Color	Black/White
Ceiling Thickness	3-20mm
Size	512*188mm
Cut out	475*175mm



WW-107-7W

LED COB

Power	7W
CCT	2700K 3000K 4000K 5000K
CRI	>90
Input voltage	110-240VAC
Beam Angel	15°,24°,40°
Color	Black/White
Ceiling Thickness	3-20mm
Size	102*102mm
Cut out	85*85mm



WW-207-2*7W

LED COB

Power	2*7W
CCT	2700K 3000K 4000K 5000K
CRI	>90
Input voltage	110-240VAC
Beam Angel	15°,24°,40°
Color	Black/White
Ceiling Thickness	3-20mm
Size	181*102mm
Cut out	160*85mm



WW-307-3*7W

LED COB

Power	3*7W
CCT	2700K 3000K 4000K 5000K
CRI	>90
Input voltage	110-240VAC
Beam Angel	15°,24°,40°
Color	Black/White
Ceiling Thickness	3-20mm
Size	255*102mm
Cut out	235*85mm

GRILLE LIGHTS



WW-010-10W

LED COB

Power	10W
CCT	2700K 3000K 4000K 5000K
CRI	>90
Input voltage	110-240VAC
Beam Angel	15°,24°,40°
Color	Black/White
Ceiling Thickness	3-20mm
Size	102*102mm
Cut out	85*85mm



WW-010-2*10W

LED COB

Power	2*10W
CCT	2700K 3000K 4000K 5000K
CRI	>90
Input voltage	110-240VAC
Beam Angel	15°,24°,40°
Color	Black/White
Ceiling Thickness	3-20mm
Size	180*102mm
Cut out	165*85mm



WW-010-3*10W

LED COB

Power	3*10W
CCT	2700K 3000K 4000K 5000K
CRI	>90
Input voltage	110-240VAC
Beam Angel	15°,24°,40°
Color	Black/White
Ceiling Thickness	3-20mm
Size	255*102mm
Cut out	240*85mm

HIGH POWER SPOTLIGHTS



WW-520

LED COB

Power	2.2W
CCT	2700K 3000K 4000K 5000K
CRI	>90
Input voltage	12VDC
Beam Angel	40°
Color	Black/White
Ceiling Thickness	3-20mm
Size	Diameter:Φ 25mm H:60mm
Cut out	Φ 20mm



WW-225

LED COB

Power	2.2W
CCT	2700K 3000K 4000K 5000K
CRI	>90
Input voltage	12VDC
Beam Angel	40°
Color	Black/White
Ceiling Thickness	3-20mm
Size	Diameter:Φ 32mm H:60mm
Cut out	Φ 25mm



WW-530

LED COB

Power	2.2W
CCT	2700K 3000K 4000K 5000K
CRI	>90
Input voltage	12VDC
Beam Angel	40°
Color	Black/White
Ceiling Thickness	3-20mm
Size	Diameter:Φ 35mm H:24mm
Cut out	Φ 30mm



WW-060B
LED COB

Power	5W
CCT	2700K 3000K 4000K 5000K
CRI	>90
Input voltage	110-240VAC
Beam Angel	20°
Color	Black/White
Ceiling Thickness	3-20mm
Size	Diameter:Φ 70mm H:90mm
Cut out	Φ 60mm



WW-060G
LED COB

Power	5W
CCT	2700K 3000K 4000K 5000K
CRI	>90
Input voltage	110-240VAC
Beam Angel	20°
Color	Black/White
Ceiling Thickness	3-20mm
Size	Diameter:Φ 70mm H:90mm
Cut out	Φ 60mm



WW-060W
LED COB

Power	5W
CCT	2700K 3000K 4000K 5000K
CRI	>90
Input voltage	110-240VAC
Beam Angel	20°
Color	Black/White
Ceiling Thickness	3-20mm
Size	Diameter:Φ 70mm H:90mm
Cut out	Φ 60mm



WW-5040

LED COB

Power	5W
CCT	2700K 3000K 4000K 5000K
CRI	>90
Input voltage	12VDC
Beam Angel	8°/15°/24°
Color	Black/White
Ceiling Thickness	3-20mm
Size	Diameter:Φ 50mm H: 95mm
Cut out	Φ 40mm

HIGH POWER SPOTLIGHTS



WW-75A 9/6W WW-75B 9/6W WW-75C 9/6W WW-75D 9/6W WW-75E 9/6W WW-75F 9/6W



WW-75G 9/6W WW-75H 9/6W WW-75I 9/6W WW-75X 10/9W

LED COB

Power	9/6W
CCT	2700K 3000K 4000K 5000K
CRI	>90
Input voltage	110-240VAC
Beam Angel	15°,24°,40° Lens:12° 24°
Color	Black/White
Ceiling Thickness	3-20mm
Size	Diameter:Φ85mm H:115mm
Cut out	Φ76mm



WW-75L 9/6W

LED COB

Power	9/6W
CCT	2700K 3000K 4000K 5000K
CRI	>90
Input voltage	110-240VAC
Beam Angel	15°,24° Lens:12° 24°
Color	Black/White
Ceiling Thickness	3-20mm
Size	Diameter:Φ95mm H:113mm
Cut out	Φ85mm



WW-75LR 9/6W

LED COB

Power	9/6W
CCT	2700K 3000K 4000K 5000K
CRI	>90
Input voltage	110-240VAC
Beam Angel	15°,24° Lens:12° 24°
Color	Black/White
Ceiling Thickness	3-20mm
Size	Diameter:95*95*113mm
Cut out	83*83mm

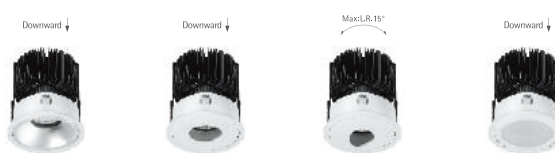

WW-585A 15W WW-585D 15W WW-585F 15W WW-585I 15W

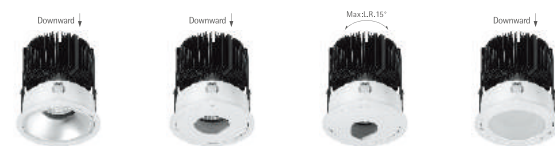

WW-895A 18W WW-895D 18W WW-895F 18W WW-895I 18W

LED COB

Power	15W
CCT	2700K 3000K 4000K 5000K
CRI	>90
Input voltage	110-240VAC
Beam Angel	15°,24°,40° Lens:12° 24°
Color	Black/White
Ceiling Thickness	3-20mm
Size	Diameter:Φ100mm H:115mm
Cut out	Φ85mm

LED COB

Power	18W
CCT	2700K 3000K 4000K 5000K
CRI	>90
Input voltage	110-240VAC
Beam Angel	15°,24°,40° Lens:12° 24°
Color	Black/White
Ceiling Thickness	3-20mm
Size	Diameter:Φ108mm H:115mm
Cut out	Φ95mm



WW-279 50W

LED COB

Power	50W
CCT	2700K 3000K 4000K 5000K
CRI	>90
Input voltage	110-240VAC
Beam Angel	15°,24°,30° Lens:12° 24°
Color	Black/White
Ceiling Thickness	3-20mm
Size	Diameter:Φ232mm H:200mm
Cut out	Φ200mm



WW-278 45W

LED COB

Power	45W
CCT	2700K 3000K 4000K 5000K
CRI	>90
Input voltage	110-240VAC
Beam Angel	15°,24°,30° Lens:12° 24°
Color	Black/White
Ceiling Thickness	3-20mm
Size	Diameter:Φ190mm H:180mm
Cut out	Φ170mm



Downward ↓

LED COB

Power	30W
CCT	2700K 3000K 4000K 5000K
CRI	>90
Input voltage	110-240VAC
Beam Angle	15°,24°,30° Lens:12° 24°
Color	Black/White
Ceiling Thickness	3-20mm
Size	Diameter:Φ150mm H:150mm
Cut out	Φ140mm

WW-277-30W



Downward ↓

LED COB

Power	24W
CCT	2700K 3000K 4000K 5000K
CRI	>90
Input voltage	110-240VAC
Beam Angle	20°,30°,60° Lens:12° 24°
Color	Black/White
Ceiling Thickness	3-20mm
Size	Diameter:Φ135mm H:150mm
Cut out	Φ125mm

WW-125A-24W



Downward ↓

LED COB

Power	24W
CCT	2700K 3000K 4000K 5000K
CRI	>90
Input voltage	110-240VAC
Beam Angle	20°,30°,60° Lens:12° 24°
Color	Black/White
Ceiling Thickness	3-20mm
Size	Diameter:Φ135mm H:153mm
Cut out	Φ125mm

WW-125AE-24W



Downward ↓

LED COB

Power	38W
CCT	2700K 3000K 4000K 5000K
CRI	>90
Input voltage	110-240VAC
Beam Angle	20°,30°,60° Lens:12° 24°
Color	Black/White
Ceiling Thickness	3-20mm
Size	Diameter:Φ160mm H:150mm
Cut out	Φ150mm

WW-150A-38W



Max:LR45°

LED COB

Power	38W
CCT	2700K 3000K 4000K 5000K
CRI	>90
Input voltage	110-240VAC
Beam Angle	20°,30°,60° Lens:12° 24°
Color	Black/White
Ceiling Thickness	3-20mm
Size	Diameter:Φ160mm H:165mm
Cut out	Φ150mm

WW-150AE-38W



Downward ↓

LED COB

Power	45W
CCT	2700K 3000K 4000K 5000K
CRI	>90
Input voltage	110-240VAC
Beam Angle	15°,24° Lens:12° 24°
Color	Black/White
Ceiling Thickness	3-20mm
Size	Diameter:Φ 135mm H:105mm
Cut out	Φ 120mm

WW-120A-45W



Downward ↓

LED COB

Power	20W
CCT	2700K 3000K 4000K 5000K
CRI	>90
Input voltage	110-240VAC
Beam Angle	15°,24°,38°,60° Lens:12° 24°
Color	Black/White
Ceiling Thickness	3-20mm
Size	Diameter:Φ 98 mm H:75mm
Cut out	Φ 88mm

WW-888A-20W



Downward ↓



Downward ↓

LED COB

Power	5W
CCT	2700K 3000K 4000K 5000K
CRI	>90
Input voltage	110-240VAC
Beam Angle	24° Lens:12° 24°
Color	Black/White
Ceiling Thickness	3-20mm
Size	Diameter:Φ 70mm H:35 mm
Cut out	Φ 62mm

WW-60AG-5W

WW-60BT-5W



Downward ↓

LED COB

Power	30W
CCT	2700K 3000K 4000K 5000K
CRI	>90
Input voltage	110-240VAC
Beam Angle	15°,24° Lens:12° 24°
Color	Black/White
Ceiling Thickness	3-20mm
Size	Diameter:Φ 130mm H:105mm
Cut out	Φ 120mm

WW-120A-30W



Downward ↓

LED COB

Power	10W
CCT	2700K 3000K 4000K 5000K
CRI	>90
Input voltage	110-240VAC
Beam Angle	15°,24°,40° Lens:12° 24°
Color	Black/White
Ceiling Thickness	3-20mm
Size	Diameter:Φ 86mm H:69mm
Cut out	Φ 75mm

WW-668A-10W



WW-470AG-5W



WW-470BT-5W

LED COB

Power ----- 5W
 CCT ----- 2700K 3000K 4000K 5000K
 CRI ----- >90
 Input voltage ----- 110-240VAC
 Beam Angel ----- 24° Lens:12° 24°
 Color ----- Black/White
 Ceiling Thickness ----- 3-20mm
 Size ----- Diameter: Φ82mm H:40mm
 Cut out ----- Φ 70mm



WW-140A-45W

LED COB

Power ----- 45W
 CCT ----- 2700K 3000K 4000K 5000K
 CRI ----- >90
 Input voltage ----- 110-240VAC
 Beam Angel ----- 15°,24° Lens:12° 24°
 Color ----- Black/White
 Ceiling Thickness ----- 3-20mm
 Size ----- Diameter: Φ 150mm H:95mm
 Cut out ----- Φ 140mm



WW-140A-30W

LED COB

Power ----- 30W
 CCT ----- 2700K 3000K 4000K 5000K
 CRI ----- >90
 Input voltage ----- 110-240VAC
 Beam Angel ----- 15°,24° Lens:12° 24°
 Color ----- Black/White
 Ceiling Thickness ----- 3-20mm
 Size ----- Diameter: Φ 150mm H:95mm
 Cut out ----- Φ 140mm



WW-108A-20W

LED COB

Power ----- 20W
 CCT ----- 2700K 3000K 4000K 5000K
 CRI ----- >90
 Input voltage ----- 110-240VAC
 Beam Angel ----- 15°,24°,38°,60° Lens:12° 24°
 Color ----- Black/White
 Ceiling Thickness ----- 3-20mm
 Size ----- Diameter: Φ 118mm H:85mm
 Cut out ----- Φ 108mm



WW-582A-10W

LED COB

Power ----- 10W
 CCT ----- 2700K 3000K 4000K 5000K
 CRI ----- >90
 Input voltage ----- 110-240VAC
 Beam Angel ----- 15°,24°,38°,60° Lens:12° 24°
 Color ----- Black/White
 Ceiling Thickness ----- 3-20mm
 Size ----- Diameter: Φ 95mm H:82mm
 Cut out ----- Φ 85mm



WW-090B 20W

LED COB

Power ----- 20W
 CCT ----- 2700K 3000K 4000K 5000K
 CRI ----- >90
 Input voltage ----- 110-240VAC
 Beam Angel ----- 15°,24°,38°,60° Lens:12° 24°
 Color ----- Black/White
 Ceiling Thickness ----- 3-20mm
 Size ----- Diameter: Φ 100mm H:87mm
 Cut out ----- Φ 90mm



WW-128B-45W

LED COB

Power ----- 45W
 CCT ----- 2700K 3000K 4000K 5000K
 CRI ----- >90
 Input voltage ----- 110-240VAC
 Beam Angel ----- 15°,24°,40° Lens:12° 24°
 Color ----- Black/White
 Ceiling Thickness ----- 3-20mm
 Size ----- Diameter: Φ 130mm H:140mm
 Cut out ----- Φ 125mm



WW-668B 10W

LED COB

Power ----- 10W
 CCT ----- 2700K 3000K 4000K 5000K
 CRI ----- >90
 Input voltage ----- 110-240VAC
 Beam Angel ----- 15°,24°,40° Lens:12° 24°
 Color ----- Black/White
 Ceiling Thickness ----- 3-20mm
 Size ----- Diameter: Φ 86mm H:86mm
 Cut out ----- Φ 75mm



WW-120B-30W

LED COB

Power ----- 30W
 CCT ----- 2700K 3000K 4000K 5000K
 CRI ----- >90
 Input voltage ----- 110-240VAC
 Beam Angel ----- 15°,24°,40° Lens:12° 24°
 Color ----- Black/White
 Ceiling Thickness ----- 3-20mm
 Size ----- Diameter: Φ 130mm H:140mm
 Cut out ----- Φ 125mm



WW-582B-10W

LED COB

Power ----- 10W
 CCT ----- 2700K 3000K 4000K 5000K
 CRI ----- >90
 Input voltage ----- 110-240VAC
 Beam Angel ----- 15°,24°,40° Lens:12° 24°
 Color ----- Black/White
 Ceiling Thickness ----- 3-20mm
 Size ----- Diameter: Φ 95mm H:96mm
 Cut out ----- Φ 85mm



LED COB

Power ----- 45 W
 CCT ----- 2700K 3000K 4000K 5000K
 CRI ----- >90
 Input voltage ----- 110-240VAC
 Beam Angel ----- 15°,24° Lens:12° 24°
 Color ----- Black/White
 Ceiling Thickness ----- 3-20mm
 Size ----- Diameter:Φ 160mm H:130mm
 Cut out ----- Φ 150mm

WW-150B-45W



LED COB

Power ----- 30W
 CCT ----- 2700K 3000K 4000K 5000K
 CRI ----- >90
 Input voltage ----- 110-240VAC
 Beam Angel ----- 15°,24° Lens:12° 24°
 Color ----- Black/White
 Ceiling Thickness ----- ~20mm
 Size ----- Diameter:Φ 160mm H:130 mm
 Cut out ----- Φ 150mm

WW-150B-30W



LED COB

Power ----- 7W
 CCT ----- 2700K 3000K 4000K 5000K
 CRI ----- >90
 Input voltage ----- 110-240VAC
 Beam Angel ----- 18°/24°/38°
 Color ----- Black/White
 Ceiling Thickness ----- 3-20mm
 Size ----- Diameter:Φ 70mm H:60mm
 Cut out ----- Φ 60mm

WW-860A-7W



LED COB

Power ----- 7W
 CCT ----- 2700K 3000K 4000K 5000K
 CRI ----- >90
 Input voltage ----- 110-240VAC
 Beam Angel ----- 18°/24°/38°
 Color ----- Black/White
 Ceiling Thickness ----- 3-20mm
 Size ----- Diameter:Φ 72mm H:82mm
 Cut out ----- Φ 60mm

WW-120B-30W



LED COB

Power ----- 10W/9W
 CCT ----- 2700K 3000K 4000K 5000K
 CRI ----- >90
 Input voltage ----- 110-240VAC
 Beam Angel ----- 15°,24°,40° Lens:12° 24°
 Color ----- Black/White
 Ceiling Thickness ----- 3-20mm
 Size ----- Diameter:Φ 100mm H:82mm
 Cut out ----- Φ 85mm

WW-088B-10/9W



LED COB

Power ----- 10W/9W
 CCT ----- 2700K 3000K 4000K 5000K
 CRI ----- >90
 Input voltage ----- 110-240VAC
 Beam Angel ----- 15°,24°,40° Lens:12° 24°
 Color ----- Black/White
 Ceiling Thickness ----- 3-20mm
 Size ----- Diameter:Φ 95mm H:82mm
 Cut out ----- Φ 85mm

WW-85XA-10/9W



LED COB

Power ----- 7W
 CCT ----- 2700K 3000K 4000K 5000K
 CRI ----- >90
 Input voltage ----- 110-240VAC
 Beam Angel ----- 18°/24°/38°
 Color ----- Black/White
 Ceiling Thickness ----- 3-20mm
 Size ----- Diameter:Φ 82mm H:72mm
 Cut out ----- Φ 70mm

WW-870A-7W



LED COB

Power ----- 7W
 CCT ----- 2700K 3000K 4000K 5000K
 CRI ----- >90
 Input voltage ----- 110-240VAC
 Beam Angel ----- 18°/24°/38°
 Color ----- Black/White
 Ceiling Thickness ----- 3-20mm
 Size ----- Diameter:Φ 80mm H:82mm
 Cut out ----- Φ 70mm

WW-870BT-7W



LED COB

Power ----- 10W/9W
 CCT ----- 2700K 3000K 4000K 5000K
 CRI ----- >90
 Input voltage ----- 110-240VAC
 Beam Angel ----- 15°,24°,40° Lens:12° 24°
 Color ----- Black/White
 Ceiling Thickness ----- 3-20mm
 Size ----- Diameter:95*95 H:82mm
 Cut out ----- 85*85mm

WW-585XK-10/9W



LED COB

Power ----- 3W
 CCT ----- 2700K 3000K 4000K 5000K
 CRI ----- >90
 Input voltage ----- 110-240VAC
 Beam Angel ----- 5° Lens:12° 24°
 Color ----- Black/White
 Ceiling Thickness ----- 3-20mm
 Size ----- Diameter:Φ 80mm H:85mm
 Cut out ----- Φ 70mm

WW-770B-3W



LED COB

Power ----- 7W
 CCT ----- 2700K 3000K 4000K 5000K
 CRI ----- >90
 Input voltage ----- 110-240VAC
 Beam Angel ----- 18°/24°/38°
 Color ----- Black/White
 Ceiling Thickness ----- 3-20mm
 Size ----- Diameter:Φ 82mm H:80mm
 Cut out ----- Φ 70mm

WW-870C-7W



LED COB

Power ----- 7W
 CCT ----- 2700K 3000K 4000K 5000K
 CRI ----- >90
 Input voltage ----- 110-240VAC
 Beam Angel ----- 18°/24°/38°
 Color ----- Black/White
 Ceiling Thickness ----- 3-20mm
 Size ----- Diameter:Φ 85mm H:70mm
 Cut out ----- Φ 70mm

WW-875D-7W



LED COB

Power	7W
CCT	2700K 3000K 4000K 5000K
CRI	>90
Input voltage	110-240VAC
Beam Angel	18°/24°/38°
Color	Black/White
Ceiling Thickness	3-20mm
Size	Diameter:Φ96mm H:90mm
Cut out	Φ85mm

WW-885-7W



LED COB

Power	20W
CCT	2700K 3000K 4000K 5000K
CRI	>90
Input voltage	110-240VAC
Beam Angel	15°,24°,38°,60° Lens:12° 24°
Color	Black/White
Ceiling Thickness	3-20mm
Size	Diameter:128*128mm
Cut out	115*115mm

WW-08C-R-20W



LED COB

Power	30W
CCT	2700K 3000K 4000K 5000K
CRI	>90
Input voltage	110-240VAC
Beam Angel	15°/24°
Color	Black/White
Ceiling Thickness	3-20mm
Size	Diameter:Φ125mm H:135mm
Cut out	Φ115mm

WW-501-30W



LED COB

Power	30W
CCT	2700K 3000K 4000K 5000K
CRI	>90
Input voltage	110-240VAC
Beam Angel	15°/24°
Color	Black/White
Ceiling Thickness	3-20mm
Size	Diameter:Φ125mm H:135mm
Cut out	Φ115mm

WW-502-35W



LED COB

Power	10W
CCT	2700K 3000K 4000K 5000K
CRI	>90
Input voltage	110-240VAC
Beam Angel	24° Lens:12° 24°
Color	Black/White
Ceiling Thickness	3-20mm
Size	Diameter:Φ86mm H:90mm
Cut out	Φ75mm

WW-10DY-10W



LED COB

Power	20W
CCT	2700K 3000K 4000K 5000K
CRI	>90
Input voltage	110-240VAC
Beam Angel	15°,24°,38° Lens:12° 24°
Color	Black/White
Ceiling Thickness	3-20mm
Size	Diameter:Φ110mm H:90mm
Cut out	Φ95mm

WW-20DY-20W



LED COB

Power	20W
CCT	2700K 3000K 4000K 5000K
CRI	>90
Input voltage	110-240VAC
Beam Angel	15°,24°,38°,60° Lens:12° 24°
Color	Black/White
Ceiling Thickness	3-20mm
Size	Diameter:Φ129mm H:75mm
Cut out	Φ120mm

WW-200A-20W



LED COB

Power	10W
CCT	2700K 3000K 4000K 5000K
CRI	>90
Input voltage	110-240VAC
Beam Angel	15°,24°,38°,60° Lens:12° 24°
Color	Black/White
Ceiling Thickness	3-20mm
Size	Diameter:Φ100mm H:70mm
Cut out	Φ90mm

WW-90DA-10W



LED COB

Power	30W
CCT	2700K 3000K 4000K 5000K
CRI	>90
Input voltage	110-240VAC
Beam Angel	15°,24° Lens:12° 24°
Color	Black/White
Ceiling Thickness	3-20mm
Size	Diameter:Φ139mm H:120mm
Cut out	Φ120mm

J C30 30
WW-30DY-30W



WW-D10-10W

LED COB

Power	10W
CCT	2700K 3000K 4000K 5000K
CRI	>90
Input voltage	110-240VAC
Beam Angel	24°
Color	Black/White
Ceiling Thickness	3-20mm
Size	Diameter: Φ87mm H:55mm
Cut out	Φ75mm

WW-D20-15W

LED COB

Power	15W
CCT	2700K 3000K 4000K 5000K
CRI	>90
Input voltage	110-240VAC
Beam Angel	24°
Color	Black/White
Ceiling Thickness	3-20mm
Size	Diameter: Φ138mm H:120mm
Cut out	Φ130mm

WW-D30-25W

LED COB

Power	25W
CCT	2700K 3000K 4000K 5000K
CRI	>90
Input voltage	110-240VAC
Beam Angel	24°
Color	Black/White
Ceiling Thickness	3-20mm
Size	Diameter: Φ163mm H:140mm
Cut out	Φ150mm

Downward ↓



WW-066-10W

LED COB

Power	10W
CCT	2700K 3000K 4000K 5000K
CRI	>90
Input voltage	110-240VAC
Beam Angel	15°, 24°, 40°
Color	Black/White
Ceiling Thickness	3-20mm
Size	Diameter: Φ100mm
Cut out	Φ85mm

Downward ↓



WW-065-10W

LED COB

Power	10W
CCT	2700K 3000K 4000K 5000K
CRI	>90
Input voltage	110-240VAC
Beam Angel	15°, 24°, 40°
Color	Black/White
Ceiling Thickness	3-20mm
Size	Diameter: 100*100mm
Cut out	85*85mm

Downward ↓



WW-25J-3W

SMD LED

Power	3W
CCT	2700K 3000K 4000K 5000K
CRI	>90
Input voltage	110-240VAC
Beam Angel	110°
Color	Black/White
Ceiling Thickness	3-20mm
Size	Diameter: Φ90mm H:72mm
Cut out	Φ80mm

Downward ↓



WW-40J-9W

SMD LED

Power	9W
CCT	2700K 3000K 4000K 5000K
CRI	>90
Input voltage	110-240VAC
Beam Angel	110°
Color	Black/White
Ceiling Thickness	3-20mm
Size	Diameter: Φ130mm H:62mm
Cut out	Φ120mm

Downward ↓



WW-60J-15W

SMD LED

Power	15W
CCT	2700K 3000K 4000K 5000K
CRI	>90
Input voltage	110-240VAC
Beam Angel	110°
Color	Black/White
Ceiling Thickness	3-20mm
Size	Diameter: Φ185mm H:65mm
Cut out	Φ165mm

Downward ↓



WW-30J-5W

SMD LED

Power	5W
CCT	2700K 3000K 4000K 5000K
CRI	>90
Input voltage	110-240VAC
Beam Angel	110°
Color	Black/White
Ceiling Thickness	3-20mm
Size	Diameter: Φ105mm H:77mm
Cut out	Φ90mm

Downward ↓



WW-50J-12W

SMD LED

Power	12W
CCT	2700K 3000K 4000K 5000K
CRI	>90
Input voltage	110-240VAC
Beam Angel	110°
Color	Black/White
Ceiling Thickness	3-20mm
Size	Diameter: Φ160mm H:65mm
Cut out	Φ152mm

Downward ↓



WW-80J-21W

SMD LED

Power	21W
CCT	2700K 3000K 4000K 5000K
CRI	>90
Input voltage	110-240VAC
Beam Angel	110°
Color	Black/White
Ceiling Thickness	3-20mm
Size	Diameter: Φ220mm H:44mm
Cut out	Φ205mm



WW-007-20

LED COB

Power	20W
CCT	2700K 3000K 4000K 5000K
CRI	>90
Input voltage	110-240VAC
Beam Angel	15°,30°,45°
Color	Black/White
Ceiling Thickness	3-20mm
Size	L:120mm H:120mm
Diameter	Φ98mm



WW-007-40

LED COB

Power	40W
CCT	2700K 3000K 4000K 5000K
CRI	>90
Input voltage	110-240VAC
Beam Angel	15°,30°,45°
Color	Black/White
Ceiling Thickness	3-20mm
Size	L:180mm H:120mm
Diameter	Φ98mm



WW-D402-Y

LED COB

Power	40W
CCT	2700K 3000K 4000K 5000K
CRI	>90
Input voltage	110-240VAC
Beam Angel	15°,30°,45°
Color	Black/White
Ceiling Thickness	3-20mm
Size	L:190mm H:130mm
Diameter	Φ114mm



WW-402-T

LED COB

Power	40W
CCT	2700K 3000K 4000K 5000K
CRI	>90
Input voltage	110-240VAC
Beam Angel	15°,30°,45°
Color	Black/White
Ceiling Thickness	3-20mm
Size	L:200mm H:210mm
Diameter	Φ98mm



WW-GD-PG10

LED COB

Power	10W
CCT	2700K 3000K 4000K 5000K
CRI	>90
Input voltage	110-240VAC
Beam Angel	15°,30°,45°
Color	Black/White
Ceiling Thickness	3-20mm
Size	L: 26 mm H:110mm
Diameter	Φ100mm



WW-252F

LED COB

Power	25W
CCT	2700K 3000K 4000K 5000K
CRI	>90
Input voltage	110-240VAC
Beam Angel	24° 60° 90°
Color	Black/White
Ceiling Thickness	3-20mm
Size	L: 55mm H:170mm
Diameter	Φ128mm

偏光：单向偏光/双向偏光

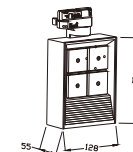

LED COB

Power	40W
CCT	2700K 3000K 4000K 5000K
CRI	>90
Input voltage	110-240VAC
Beam Angel	40x80°
Color	Black/White
Ceiling Thickness	3-20mm
Size	L: 55 mm H:170mm
Diameter	Φ128mm

偏光：单向偏光/双向偏光



WW-182-X

LED COB

Power	18W
CCT	2700K 3000K 4000K 5000K
CRI	>90
Input voltage	110-240VAC
Beam Angel	15°,30°,45°
Color	Black/White
Ceiling Thickness	3-20mm
Size	L:185mm H:120mm
Diameter	Φ80mm



WW-302-X

LED COB

Power	30W
CCT	2700K 3000K 4000K 5000K
CRI	>90
Input voltage	110-240VAC
Beam Angel	15°,30°,45°
Color	Black/White
Ceiling Thickness	3-20mm
Size	L:110mm H:120mm
Diameter	Φ104mm



WW-LG25-Q

LED COB

Power	25W
CCT	2700K 3000K 4000K 5000K
CRI	>90
Input voltage	110-240VAC
Beam Angel	15°,30°,45°
Color	Black/White
Ceiling Thickness	3-20mm
Size	L:110mm H:120mm
Diameter	Φ104mm



WW-352-X

LED COB

Power	35W
CCT	2700K 3000K 4000K 5000K
CRI	>90
Input voltage	110-240VAC
Beam Angel	15°,30°,45°
Color	Black/White
Ceiling Thickness	3-20mm
Size	L:198mm H:120mm
Diameter	Φ75mm



LED COB

Power ----- 5*2W
 CCT ----- 2700K 3000K 4000K 5000K
 CRI ----- >90
 Input voltage --- 110-240VAC
 Beam Angel --- 15°,30°,45°
 Color ----- Black/White
 Ceiling Thickness --- 3-20mm
 Size ----- L:136mm H:190mm
 Diameter ----- Φ 33mm

WW-XT103



LED COB

Power ----- 10*2W
 CCT ----- 2700K 3000K 4000K 5000K
 CRI ----- >90
 Input voltage --- 110-240VAC
 Beam Angel --- 15°, 30°,45°
 Color ----- Black/White
 Ceiling Thickness --- 3-20mm
 Size ----- L:270mm H:196mm
 Diameter ----- Φ 35mm

WW-XT203



LED COB

Power ----- 15W
 CCT ----- 2700K 3000K 4000K 5000K
 CRI ----- >90
 Input voltage --- 110-240VAC
 Beam Angel --- 15°,24°,38° Lens:12°,24°
 Color ----- Black/White
 Ceiling Thickness --- 3-20mm
 Size ----- L:185mm H:123mm
 Diameter ----- Φ 75mm

WW-005-15W



LED COB

Power ----- 25W
 CCT ----- 2700K 3000K 4000K 5000K
 CRI ----- >90
 Input voltage --- 110-240VAC
 Beam Angel --- 15°,24°,38° Lens:12°,24°
 Color ----- Black/White
 Ceiling Thickness --- 3-20mm
 Size ----- L:210mm H:123mm
 Diameter ----- Φ 75mm

WW-005-25W



LED COB

Power ----- 15W
 CCT ----- 2700K 3000K 4000K 5000K
 CRI ----- >90
 Input voltage --- 110-240VAC
 Beam Angel --- 15°,24°,38° Lens:12°,24°
 Color ----- Black/White
 Ceiling Thickness --- 3-20mm
 Size ----- L:185mm H:123mm
 Diameter ----- Φ 75mm

WW-005-35W



LED COB

Power ----- 20W
 CCT ----- 2700K 3000K 4000K 5000K
 CRI ----- >90
 Input voltage --- 110-240VAC
 Beam Angel --- 10°,23°,38° Lens:12°,24°,38°
 Color ----- Black/White
 Ceiling Thickness --- 3-20mm
 Size ----- L:160mm H:210mm
 Diameter ----- Φ 85mm

WW-0SS-20W



LED COB

Power ----- 30W
 CCT ----- 2700K 3000K 4000K 5000K
 CRI ----- >90
 Input voltage --- 110-240VAC
 Beam Angel --- 10°,23°,38° Lens:12°,24°,38°
 Color ----- Black/White
 Ceiling Thickness --- 3-20mm
 Size ----- L:180mm H:210mm
 Diameter ----- Φ 85mm

WW-0SS-30W



LED COB

Power ----- 20W
 CCT ----- 2700K 3000K 4000K 5000K
 CRI ----- >90
 Input voltage --- 110-240VAC
 Beam Angel --- 10°,23°,38° Lens:12°,24°,38°
 Color ----- Black/White
 Ceiling Thickness --- 3-20mm
 Size ----- L:160mm H:210mm
 Diameter ----- Φ120mm

WW-20S-20W



LED COB

Power ----- 20W
 CCT ----- 2700K 3000K 4000K 5000K
 CRI ----- >90
 Input voltage --- 110-240VAC
 Beam Angel --- 10°,23°,38° Lens:12°,24°,38°
 Color ----- Black/White
 Ceiling Thickness --- 3-20mm
 Size ----- L:220mm H:210mm
 Diameter ----- Φ120mm

WW-45S-45W



LED COB

Power ----- 45W
 CCT ----- 2700K 3000K 4000K 5000K
 CRI ----- >90
 Input voltage --- 110-240VAC
 Beam Angel --- 10°,23°,38° Lens:12°,24°,38°
 Color ----- Black/White
 Ceiling Thickness --- 3-20mm
 Size ----- L:200mm H:210mm
 Diameter ----- Φ 85mm

WW-5SS-45W



LED COB

Power ----- 30W
 CCT ----- 2700K 3000K 4000K 5000K
 CRI ----- >90
 Input voltage --- 110-240VAC
 Beam Angel --- 10°,23°,38° Lens:12°,24°,38°
 Color ----- Black/White
 Ceiling Thickness --- 3-20mm
 Size ----- L:180mm H:210mm
 Diameter ----- Φ120mm

WW-30S-30W



LED COB

Power ----- 20W
 CCT ----- 2700K 3000K 4000K 5000K
 CRI ----- >90
 Input voltage --- 110-240VAC
 Beam Angel --- 10°,20°
 Color ----- Black/White
 Ceiling Thickness --- 3-20mm
 Size ----- L:110mm H:230mm
 Diameter ----- Φ103mm

WW-302Y-30W



LED COB

Power ----- 45W
 CCT ----- 2700K 3000K 4000K 5000K
 CRI ----- >90
 Input voltage 110-240VAC
 Beam Angle 15°,24°,38° Lens:12°,24°
 Color ----- Black/White
 Ceiling Thickness 3-20mm
 Size ----- L:177 mm H:225mm
 Diameter ----- Φ98mm

WW-502-Z-45W



LED COB

Power ----- 30W
 CCT ----- 2700K 3000K 4000K 5000K
 CRI ----- >90
 Input voltage 110-240VAC
 Beam Angle 15°,24°,38° Lens:12°,24°
 Color ----- Black/White
 Ceiling Thickness 3-20mm
 Size ----- L:145 mm H:210mm
 Diameter ----- Φ98mm

WW-302-Z-30W



LED COB

Power ----- 18W 30W
 CCT ----- 2700K 3000K 4000K 5000K
 CRI ----- >90
 Input voltage 110-240VAC
 Beam Angle 15°,24° Lens:12°,24°
 Color ----- Black/White
 Ceiling Thickness 3-20mm
 Size ----- L:128mm H:170mm
 Diameter ----- Φ75mm

WW-18T2-18W

WW-30T2-30W



LED COB

Power ----- 20W
 CCT ----- 2700K 3000K 4000K 5000K
 CRI ----- >90
 Input voltage 110-240VAC
 Beam Angle 15°,24°,38° Lens:12°,24°
 Color ----- Black/White
 Ceiling Thickness 3-20mm
 Size ----- L:110 mm H:210 mm
 Diameter ----- Φ98mm

WW-202-Z-20W



LED COB

Power ----- 15W
 CCT ----- 2700K 3000K 4000K 5000K
 CRI ----- >90
 Input voltage 110-240VAC
 Beam Angle 15°,24°,38° Lens:12°,24°
 Color ----- Black/White
 Ceiling Thickness 3-20mm
 Size ----- L:125 mm H:240 mm
 Diameter ----- Φ75mm

WW-GD7515



LED COB

Power ----- 45W 35W 20W
 CCT ----- 2700K 3000K 4000K 5000K
 CRI ----- >90
 Input voltage 110-240VAC
 Beam Angle 15°,24° Lens:12°,24°
 Color ----- Black/White
 Ceiling Thickness 3-20mm
 Size ----- L:128mm H:170mm
 Diameter ----- Φ75mm

WW-452T-45W

WW-352T-35W

WW-202T-20W



LED COB

Power ----- 7W 13W
 CCT ----- 2700K 3000K 4000K 5000K
 CRI ----- >90
 Input voltage 110-240VAC
 Beam Angle 15°,24°,38° Lens:12°,24°
 Color ----- Black/White
 Ceiling Thickness 3-20mm
 Size ----- L:160 mm H:160 mm
 Diameter ----- Φ50mm

WW-ST3-13W

WW-ST3-7W



LED COB

Power ----- 45W
 CCT ----- 2700K 3000K 4000K 5000K
 CRI ----- >90
 Input voltage 110-240VAC
 Beam Angle 15°,24° Lens:12°,24°
 Color ----- Black/White
 Ceiling Thickness 3-20mm
 Size ----- L:110 mm H:240mm
 Diameter ----- Φ105mm

WW-105A-45W



LED COB

Power ----- 30W
 CCT ----- 2700K 3000K 4000K 5000K
 CRI ----- >90
 Input voltage 110-240VAC
 Beam Angle 15°,24° Lens:12°,24°
 Color ----- Black/White
 Ceiling Thickness 3-20mm
 Size ----- L:100mm H:240mm
 Diameter ----- Φ105mm

WW-104A-30W



LED COB

Power	20W
CCT	2700K 3000K 4000K 5000K
CRI	>90
Input voltage	110-240VAC
Beam Angle	15°,24°,38° Lens:12°,24°
Color	Black/White
Ceiling Thickness	3-20mm
Size	L:85mm H:200mm
Diameter	Φ85mm

WW-85A-20W



LED COB

Power	45W
CCT	2700K 3000K 4000K 5000K
CRI	>90
Input voltage	110-240VAC
Beam Angle	15°,24° Lens:12°,24°
Color	Black/White
Ceiling Thickness	3-20mm
Size	L:105mm H:160mm
Diameter	Φ112mm

WW-105-45W



LED COB

Power	20W
CCT	2700K 3000K 4000K 5000K
CRI	>90
Input voltage	110-240VAC
Beam Angle	15°,24°,38° Lens:12°,24°
Color	Black/White
Ceiling Thickness	3-20mm
Size	L:85mm H:210mm
Diameter	Φ95mm

WW-85-20W



LED COB

Power	10W
CCT	2700K 3000K 4000K 5000K
CRI	>90
Input voltage	110-240VAC
Beam Angle	25° Lens:12°,24°
Color	Black/White
Ceiling Thickness	3-20mm
Size	L:80mm H:180mm
Diameter	Φ65mm

WW-65A-10W



LED COB

Power	30W
CCT	2700K 3000K 4000K 5000K
CRI	>90
Input voltage	110-240VAC
Beam Angle	15°,24° Lens:12°,24°
Color	Black/White
Ceiling Thickness	3-20mm
Size	L:105mm H:250mm
Diameter	Φ110mm

WW-104-30W



LED COB

Power	10W
CCT	2700K 3000K 4000K 5000K
CRI	>90
Input voltage	110-240VAC
Beam Angle	15° Lens:12°,24°
Color	Black/White
Ceiling Thickness	3-20mm
Size	L:70mm H:180mm
Diameter	Φ80mm

WW-65-10W



LED COB

Power	45W
CCT	2700K 3000K 4000K 5000K
CRI	>90
Input voltage	110-240VAC
Beam Angle	15°,24° Lens:12°,24°
Color	Black/White
Ceiling Thickness	3-20mm
Size	L:105mm H:141mm
Diameter	Φ112mm

WW-85A-45W



LED COB

Power	20W
CCT	2700K 3000K 4000K 5000K
CRI	>90
Input voltage	110-240VAC
Beam Angle	15°,24°,38°,60° Lens:12°,24°
Color	Black/White
Ceiling Thickness	3-20mm
Size	L:84mm H:141mm
Diameter	Φ66mm

WW-85A-20W



LED COB

Power	45W
CCT	2700K 3000K 4000K 5000K
CRI	>90
Input voltage	110-240VAC
Beam Angle	15°,24° Lens:12°,24°
Color	Black/White
Ceiling Thickness	3-20mm
Size	L:105mm H:141mm
Diameter	Φ112mm

WW-105A-45W



LED COB

Power	30W
CCT	2700K 3000K 4000K 5000K
CRI	>90
Input voltage	110-240VAC
Beam Angle	15°,24° Lens:12°,24°
Color	Black/White
Ceiling Thickness	3-20mm
Size	L:84mm H:141mm
Diameter	Φ93mm

WW-104A-30W



LED COB

Power	10W
CCT	2700K 3000K 4000K 5000K
CRI	>90
Input voltage	110-240VAC
Beam Angle	15° Lens:12°,24°
Color	Black/White
Ceiling Thickness	3-20mm
Size	L:80mm H:141mm
Diameter	Φ65mm

WW-65A-10W



LED COB

Power	30W
CCT	2700K 3000K 4000K 5000K
CRI	>90
Input voltage	110-240VAC
Beam Angle	15°,24° Lens:12°,24°
Color	Black/White
Ceiling Thickness	3-20mm
Size	L:84mm H:141mm
Diameter	Φ93mm

WW-104-30W



LED COB

Power	20W
CCT	2700K 3000K 4000K 5000K
CRI	>90
Input voltage	110-240VAC
Beam Angel	15°,24°,38° Lens:12°,24°
Color	Black/White
Ceiling Thickness	3-20mm
Size	L:84mm H:141mm
Diameter	Φ66mm

WW-85-20W



LED COB

Power	10W
CCT	2700K 3000K 4000K 5000K
CRI	>90
Input voltage	110-240VAC
Beam Angel	15° Lens:12°,24°
Color	Black/White
Ceiling Thickness	3-20mm
Size	L:80mm H:141mm
Diameter	Φ43mm

WW-65-10W



LED COB

Power	7W
CCT	2700K 3000K 4000K 5000K
CRI	>90
Input voltage	110-240VAC
Beam Angel	15°,24°,40° Lens:12°,24°
Color	Black/White
Ceiling Thickness	3-20mm
Size	H:120mm
Diameter	Φ62mm

WW-ST1-7W



LED COB

Power	7W
CCT	2700K 3000K 4000K 5000K
CRI	>90
Input voltage	110-240VAC
Beam Angel	15°,24°,40° Lens:12°,24°
Color	Black/White
Ceiling Thickness	3-20mm
Size	H:120mm
Diameter	Φ62mm

WW-ST1-7W



LED COB

Power	5W
CCT	2700K 3000K 4000K 5000K
CRI	>90
Input voltage	110-240VAC
Beam Angel	24°
Color	Black/White
Ceiling Thickness	3-20mm
Size	L:80mm H:141mm
Diameter	Φ43mm

WW-LG05-5W



LED COB

Power	5W
CCT	2700K 3000K 4000K 5000K
CRI	>90
Input voltage	110-240VAC
Beam Angel	24°
Color	Black/White
Ceiling Thickness	3-20mm
Size	L:80mm H:141mm
Diameter	Φ43mm

WW-JG05-5W



LED COB

Power	7W
CCT	2700K 3000K 4000K 5000K
CRI	>90
Input voltage	110-240VAC
Beam Angel	15°,24°,40° Lens:12°,24°
Color	Black/White
Ceiling Thickness	3-20mm
Size	H:120mm
Diameter	Φ53mm

WW-ST4-7W



LED COB

Power	7W
CCT	2700K 3000K 4000K 5000K
CRI	>90
Input voltage	110-240VAC
Beam Angel	15°,24°,40° Lens:12°,24°
Color	Black/White
Ceiling Thickness	3-20mm
Size	H:120mm
Diameter	Φ53mm

WW-ST4-7W



LED COB

Power	5W
CCT	2700K 3000K 4000K 5000K
CRI	>90
Input voltage	110-240VAC
Beam Angel	24°
Color	Black/White
Ceiling Thickness	3-20mm
Size	L:80mm
Diameter	Φ43mm

WW-LG05-Q-5W



LED COB

Power	5W
CCT	2700K 3000K 4000K 5000K
CRI	>90
Input voltage	110-240VAC
Beam Angel	24°
Color	Black/White
Ceiling Thickness	3-20mm
Size	L:80mm
Diameter	Φ43mm

WW-JG05-QW



LED COB

Power	3W
CCT	2700K 3000K 4000K 5000K
CRI	>90
Input voltage	110-240VAC
Beam Angel	5°
Color	Black/White
Ceiling Thickness	3-20mm
Size	H:120mm
Diameter	Φ55mm

WW-ST403-3W



LED COB

Power	3W
CCT	2700K 3000K 4000K 5000K
CRI	>90
Input voltage	110-240VAC
Beam Angel	5°
Color	Black/White
Ceiling Thickness	3-20mm
Size	H:120mm
Diameter	Φ55mm

WW-ST403-3W



LED COB

Power	7W
CCT	2700K 3000K 4000K 5000K
CRI	>90
Input voltage	110-240VAC
Beam Angel	15°,24°,40° Lens:12°,24°
Color	Black/White
Ceiling Thickness	3-20mm
Size	H:120mm
Diameter	Φ52mm

WW-ST4L-7W



LED COB

Power	7W
CCT	2700K 3000K 4000K 5000K
CRI	>90
Input voltage	110-240VAC
Beam Angel	15°,24°,40° Lens:12°,24°
Color	Black/White
Ceiling Thickness	3-20mm
Size	H:120mm
Diameter	Φ52mm

WW-XST4L-7W



LED COB

Power	25W
CCT	2700K 3000K 4000K 5000K
CRI	>90
Input voltage	110-240VAC
Beam Angel	
Color	Black/White
Ceiling Thickness	3-20mm

WW-509T



Technical Parameters

Light Source	LED OSRAM SMG
Power	Max 45W
CCT	2700K / 3000K / 4000K / 5000K
CRI	>80
Input Voltage	AC 220-240V
Finishing Color	White,Black,Silver
Net Weight	1.15kg/pc
QTY/CTN	10 PCS

340 201

WW-09T



LED COB

Power	5W 7W
CCT	2700K 3000K 4000K 5000K
CRI	>90
Input voltage	110-240VAC
Beam Angel	18°,24°,38°
Color	Black/White
Ceiling Thickness	3-20mm
Size	H:100mm
Diameter	Φ50mm

WW-ST5-5W/7W



LED COB

Power	5W 7W
CCT	2700K 3000K 4000K 5000K
CRI	>90
Input voltage	110-240VAC
Beam Angel	18°,24°,38°
Color	Black/White
Ceiling Thickness	3-20mm
Size	H:100mm
Diameter	Φ50mm

WW-XST5-5W/7W



LED COB

Power	30W
CCT	2700K 3000K 4000K 5000K
CRI	>90
Input voltage	110-240VAC
Beam Angel	30°
Color	Black/White
Ceiling Thickness	3-20mm
Size	H:200mm
Diameter	Φ300mm

WW-0135



LED COB

Power	10W
CCT	2700K 3000K 4000K 5000K
CRI	>90
Input voltage	110-240VAC
Beam Angel	15°,24°,38°,60° Lens:12°,24°
Color	Black/White
Ceiling Thickness	3-20mm
Size	H: 98mm
Diameter	Φ120mm

WW-101-10W



LED COB

Power	10W/9W
CCT	2700K 3000K 4000K 5000K
CRI	>90
Input voltage	110-240VAC
Beam Angel	15°,24°,40° Lens:12°,24°
Color	Black/White
Ceiling Thickness	3-20mm
Size	H:145mm
Diameter	Φ70mm

WW-70A-10W/9W



LED COB

Power	10W/9W
CCT	2700K 3000K 4000K 5000K
CRI	>90
Input voltage	110-240VAC
Beam Angel	15°,24°,40° Lens:12°,24°
Color	Black/White
Ceiling Thickness	3-20mm
Size	H:145mm
Diameter	Φ70mm

WW-010-10W/9W



LED COB

Power	20W
CCT	2700K 3000K 4000K 5000K
CRI	>90
Input voltage	110-240VAC
Beam Angel	15°,24°,38°,60° Lens:12°,24°
Color	Black/White
Ceiling Thickness	3-20mm
Size	H: 98mm
Diameter	Φ120mm

WW-201-20W



LED COB

Power	30W
CCT	2700K 3000K 4000K 5000K
CRI	>90
Input voltage	110-240VAC
Beam Angel	15°,24°,38°,60° Lens:12°,24°
Color	Black/White
Ceiling Thickness	3-20mm
Size	H: 98mm
Diameter	Φ160mm

WW-301-20W



BMT401/40W

WW-BMT401-40W

LED COB

Power	40W
CCT	2700K 3000K 4000K 5000K
CRI	>90
Input voltage	110-240VAC
Beam Angel	15°,24°,38°,60° Lens:12°,24°
Color	Black/White
Ceiling Thickness	3-20mm
Size	H:98mm
Diameter	Φ200mm

WW-MTC-9W

LED COB

Power	9W
CCT	2700K 3000K 4000K 5000K
CRI	>90
Input voltage	110-240VAC
Beam Angel	15°,24° Lens:12°,24°
Color	Black/White
Ceiling Thickness	3-20mm
Size	H:140mm
Diameter	Φ60mm

WW-MTC-20W

LED COB

Power	20W
CCT	2700K 3000K 4000K 5000K
CRI	>90
Input voltage	110-240VAC
Beam Angel	15°,24° Lens:12°,24°
Color	Black/White
Ceiling Thickness	3-20mm
Size	H:160mm
Diameter	Φ120mm

LED COB

Power	30W
CCT	2700K 3000K 4000K 5000K
CRI	>90
Input voltage	110-240VAC
Beam Angel	15°,24° Lens:12°,24°
Color	Black/White
Ceiling Thickness	3-20mm
Size	H:210mm
Diameter	Φ140mm

WW-MTC-15W

LED COB

Power	15W
CCT	2700K 3000K 4000K 5000K
CRI	>90
Input voltage	110-240VAC
Beam Angel	15°,24° Lens:12°,24°
Color	Black/White
Ceiling Thickness	3-20mm
Size	H:140mm
Diameter	Φ90mm

Downward ↓



WW-MTC-R-9W

LED COB

Power	9W
CCT	2700K 3000K 4000K 5000K
CRI	>90
Input voltage	110-240VAC
Beam Angel	15°,24° Lens:12°,24°
Color	Black/White
Ceiling Thickness	3-20mm
Size	H:140mm
Diameter	700*70mm

WW-MTC-R-15W

LED COB

Power	15W
CCT	2700K 3000K 4000K 5000K
CRI	>90
Input voltage	110-240VAC
Beam Angel	15°,24° Lens:12°,24°
Color	Black/White
Ceiling Thickness	3-20mm
Size	H:140mm
Diameter	100*100mm

Hanging light



WW-503-3.5W WW-003-3.5W

LED COB

Power 3W
 CCT 2700K 3000K 4000K 5000K
 CRI >90
 Input voltage 110-240VAC
 Beam Angel 40° 80°
 Color Black/White

WW-515-15W

LED COB

Power 15W
 CCT 2700K 3000K 4000K 5000K
 CRI >90
 Input voltage 110-240VAC
 Beam Angel 15° 24° 38° 60°
 Color Black/White



WW-DX60



Power 14W
 CCT 3000K 4000K 6000K
 CRI >75
 Input voltage 110-240VAC
 Beam Angel 360°
 Color White



WW-DX4875

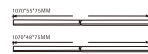

Power 20W / 28W
 CCT 3000K 4000K 6000K
 CRI >75
 Input voltage 110-240VAC
 Beam Angel 360°
 Color White



WW-307/308



Power 12W / 16W
 CCT 3000K 4000K 6000K
 CRI >75
 Input voltage 110-240VAC
 Beam Angel 360°
 Color White



WW-780/580

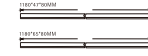

Power 12W / 16W
 CCT 3000K 4000K 6000K
 CRI >75
 Input voltage 110-240VAC
 Beam Angel 360°
 Color White



WW-5050/5075/7070

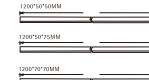

Power 16W
 CCT 3000K 4000K 6000K
 CRI >75
 Input voltage 110-240VAC
 Beam Angel 360°
 Color White



WW-60120



Power 33W
 CCT 4000K 6000K
 CRI >75
 Input voltage 110-240VAC
 Beam Angel 120°
 Color White



WW-6060



Power 36W
 CCT 4000K 6000K
 CRI >75
 Input voltage 110-240VAC
 Beam Angel 120°
 Color White



WW-30120



Power 54W
 CCT 4000K 6000K
 CRI >75
 Input voltage 110-240VAC
 Beam Angel 120°
 Color White



WW-11870



Power 33W
 CCT 4000K 6000K
 CRI >75
 Input voltage 110-240VAC
 Beam Angel 120°
 Color White



wash wall light

WW-XQ3325



Power 12W
 CCT 3000K 4000K 6000K
 CRI >75
 Input voltage 110-240VAC
 Beam Angel 30° 60°
 Color White
 筒光: 30° /60° /单筒光



Can be unlimited joint, 可无限拼接

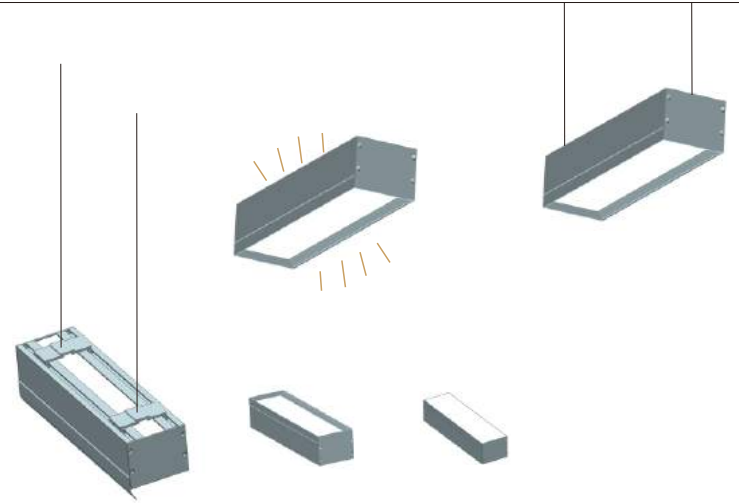

WW-XQ7862-T

WW-XQ7862-P

Power 15W
 CCT 3000K 4000K 6000K
 CRI >75
 Input voltage 110-240VAC
 Beam Angel 30° 60° 90° 120° 180° 单筒光 双筒光
 Color White

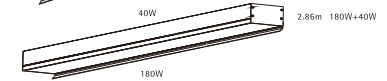
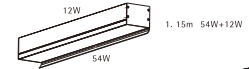
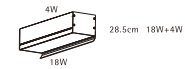
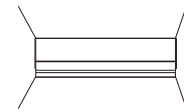

SMD LAMP WITH



LED	285	LED/m	60pcs
Power	10W/m	Voltage	DC 24V
IP Rating	IP65	Max Length	50m/reel
Dimensions	W14*T7mm	Cutting Unit	10cm (6LEDs)
Material	Copper+PVC	PCB Width	8mm
CRI	>80	Lm/led	24-26mm

T5 LED TUBE



WW-T5-1168MM

BJ-T5-1168MM

Power	14W
CCT	2700K 4000K 6400K
CRI	>75(min)
Input voltage	110-230VAC
Configuration	LED Driver

High brightness of SMD2835
Luminous efficiency is 13lm/LED

WW-T5-308MM

BJ-T5-308MM

Power	4W
CCT	2700K 4000K 6400K
CRI	>75(min)
Input voltage	110-230VAC
Configuration	LED Driver

High brightness of SMD2835
Luminous efficiency is 13lm/LED

WW-T5-870MM

BJ-T5-870MM

Power	10W
CCT	2700K 4000K 6400K
CRI	>75(min)
Input voltage	110-230VAC
Configuration	LED Driver

High brightness of SMD2835
Luminous efficiency is 13lm/LED

WW-T5-570MM

BJ-T5-570MM

Power	7W
CCT	2700K 4000K 6400K
CRI	>75(min)
Input voltage	110-230VAC
Configuration	LED Driver

High brightness of SMD2835
Luminous efficiency is 13lm/LED

CORNER LAMP



WW-6363-2W

Power	2W
CCT	2700K 3000K
CRI	>75
Input voltage	110-240VAC
Color	White
Ceiling Thickness	3-20mm
Size	63*63mm



WW-86B-2W

Power	2W
CCT	2700K 3000K
CRI	>75
Input voltage	110-240VAC
Color	White
Ceiling Thickness	3-20mm
Size	100*100mm



WW-4060-2W

Power	2W
CCT	2700K 3000K
CRI	>75
Input voltage	110-240VAC
Beam Angel	30°
Color	White
Ceiling Thickness	3-20mm
Size	140*60mm



WW-JD1A WW-JD13 WW-JD2B WW-JD11-1W

Power	1W
CCT	3000K
CRI	>75
Input voltage	110-240VAC
Size	100*100mm



WW-D02B

Power	2W
CCT	3000K
CRI	>75
Input voltage	110-240VAC
Beam Angel	30°
Color	White
Ceiling Thickness	3-20mm

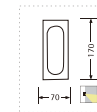

WW-D02A

Power	2W
CCT	3000K
CRI	>75
Input voltage	110-240VAC
Beam Angel	30°
Color	White
Ceiling Thickness	3-20mm

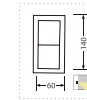

Wall Lighting



WW-106

Power	5W
CCT	3000K
CRI	>75
Input voltage	110-240VAC
Beam Angel	30°
Color	White
Ceiling Thickness	3-20mm



Free combination



① Model ② Outer ring

Optional variety of the size of holes, ensure lamps and lanterns of different space appearance consistency, double reflection cup design, Depth of anti-glare, secondary reflection using spray white, wash the wall in the effective at the same time, avoid stay, The integration of efficient cooling heat dissipation structure design, Reduce light decay, various beam Angle of optional, suitable for different height space.

Applications:
Star hotel, dining room, coffee shop, trade fair, corridor or bedroom etc



⑥ Each of the specifications of the lamp holder with 6 kinds of reflective cup